

### STEP 6

Connect the steel bracket from the back to the frame using the counter sink screw (E), then connect the other back to the steel bracket using the mounting screw (D). Then screw in the locking wheel.

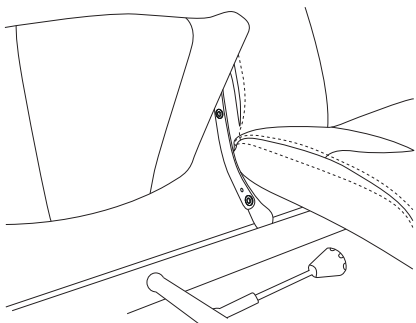

### STEP 7

Tilt the seat to the front and connect the seat with the locking bolt (B).

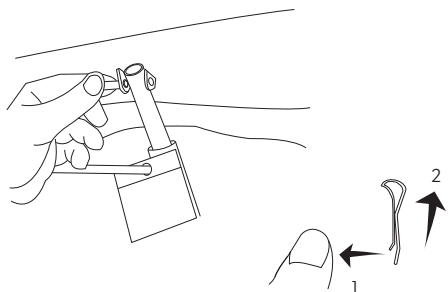

### STEP 8

The sofa have height adjustable neck. Loosen the plastic bag containing 2 pc of clips. Put the clips in the plastic tubes like shown on the sketch. When the clips are attached put on the neck by inserting the steel rods into the holes at the top of the back.

Notice: Headrest Clips are included in the Assembling guide bag- put in the carton box, Install headrest clips before installing headrest.

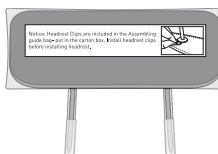
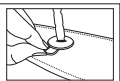

Notice: Headrest Clips are included in the Assembling guide bag- put in the carton box, Install headrest clips before installing headrest.

## ASSEMBLY INSTRUCTIONS FUNCTION SOFA / MONTERINGSVEILEDNING FUNKSJONS SOFA

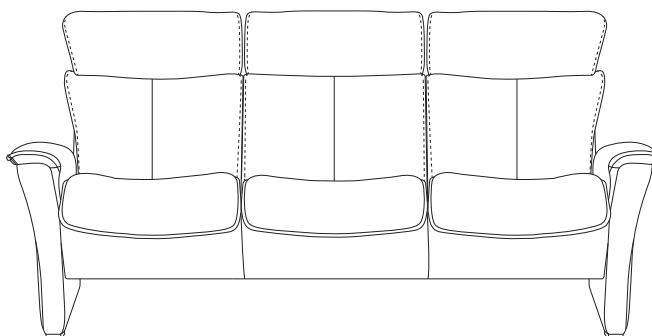
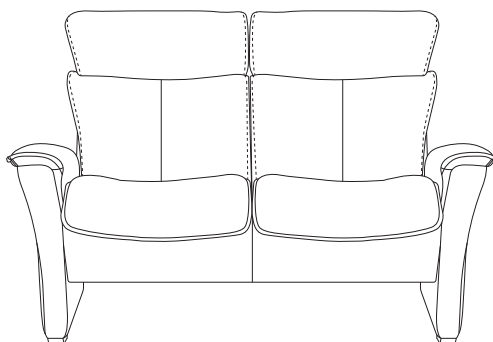
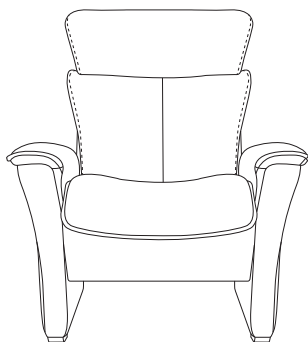

### CONGRATULATION, YOUR SOFA IS NOW READY FOR USE

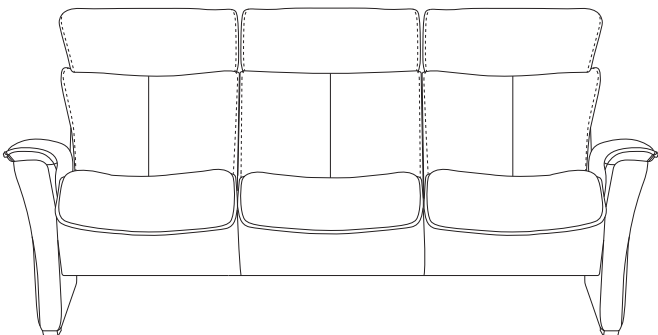

**Note:** Please re-tighten all visible bolts and screws every 4 months or as needed to ensure long lasting performance of your sofa.

**NB!** Undersøk alle skruer og etter stram hver 4. måned eller om nødvendig oftere, for å sikre langvarig ytelse av sofaen.

## CONGRATULATIONS / GRATULERER

You are now the proud owner of a Function sofa from IMG. We are confident you will enjoy the comfort and style of this new furniture

Du er nå den stolte eier av en Funksjon sofa fra IMG. Vi er sikre på at du vil nyte komforten og stilen på dine nye møbler

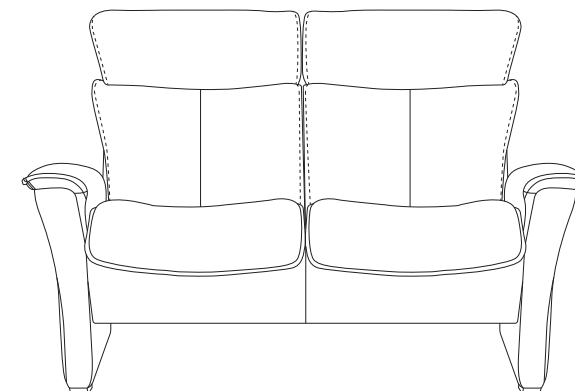



ASSEMBLY INSTRUCTIONS / MONTERINGSVEILEDNING

### IMPORTANT / VIKTIG

Read this and other relevant instructions before using the product. Keep this manual for future reference.

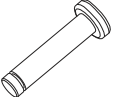
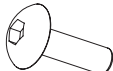
Les denne og andre relevante instruksjoner før du bruker produktet. Oppbevar denne håndboken for fremtidig referanse.

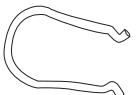
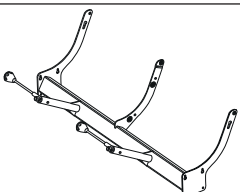
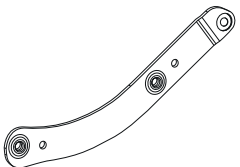
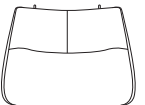
CONTENTS / INNHOLD	
<b>A</b> Clip 1 pc per seat / Klips 1 stk per sitteplass	
<b>B</b> Locking bolt 1 pc per set / Låsebolt 1 stk per sitteplass	
<b>C</b> Mobel screw 8 pc per sofa / Møbel skru 8 stk per sofa	
<b>D</b> Mounting screw 4 pc per sofa / Festeskrue 4 stk per sofa	
<b>E</b> Counter sink screw / Senkehode skru	
<b>F</b> Headrest clip 2 pc per headrest / Nakkepute klips 2 stk per nakke	
<b>G</b> Steel frame 1 pc per sofa / Stålramme 1 stk per sofa	
<b>H</b> Back bracket 1 pc per back / Rygg brakett 1 stk per rygg	
<b>I</b> Seat 1 pc per seating / Sete 1 stk per sitteplass	

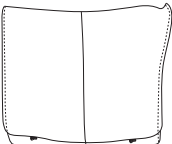
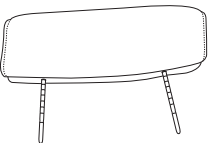
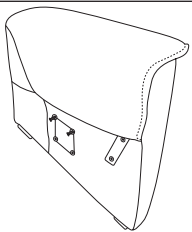
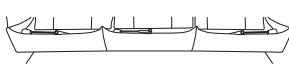
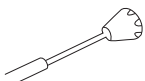
CONTENTS / INNHOLD	
<b>J</b> Back cushion 1 pc per seating / Ryggpute 1 stk per sitteplass	
<b>K</b> Headrest 1 pc per back / Nakkepute 1 stk per rygg	
<b>L</b> Arm 1 pair per sofa / Arm 1 par per sofa	
<b>M</b> Front panel 1 pc per sofa / Front panel 1 stk per sofa	
<b>N</b> Locking wheel 1 pc per seating / Låsehjul 1 stk per seteplass	

## ASSEMBLY INSTRUCTIONS FUNCTION SOFA / MONTERINGSVEILEDNING FUNKSJONS SOFA

### STEP 1

Release the pin from under the seat and set the seat aside

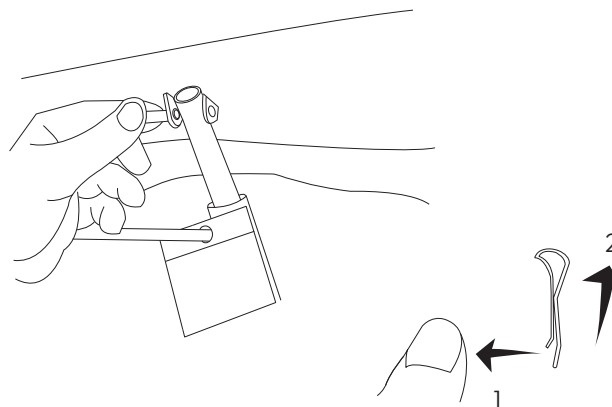

### STEP 2

Screw the steel bracket on to the back using the mounting screw (D)

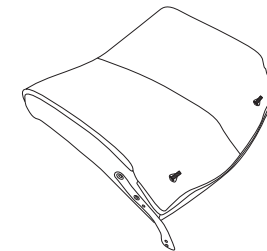

### STEP 3

Screw in mobil screws loosely (C) into the holes of the arms (see arrows)

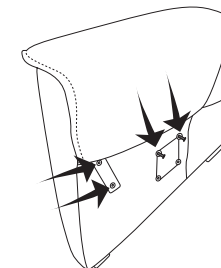

### STEP 4

Connect the arms to the frame, by threading the keyholes of the frame to the mobil screws. Then screw in two mobil screws in the bottom holes on the frame.

**NOTE:** Do not tighten the screws

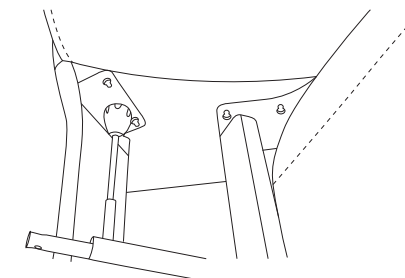

Then connect the front panel by threading the keyholes on the panel bracket to the mobil screws on the front of the arm. Then tighten all screws on the arm.

### STEP 5

Connect the seat to the back by sliding the holes on the seat on the pegs of the back.

**NOTE:** One back peg is longer than the other to make lining up the holes easier. Fasten the clip into the peg slot.

